



WOLF[®]

DESIGNER CABINETS

Real performance. Real value.

*CARE and
MAINTENANCE
GUIDE*

*Information and tips
on maintaining the beauty
and function of your
WOLF Designer Cabinets*

THANK YOU & CONGRATULATIONS

Thank you for choosing WOLF Designer Cabinets for your home. By selecting WOLF Designer Cabinets, you have chosen a product with exceptional style and carefully crafted details.

To ensure that you are satisfied with your new cabinetry for years to come, we have prepared this guide to help you maintain and care for your investment.

TABLE OF CONTENTS:

Product Characteristics & Variations	3
Care & Maintenance Tips	5
Door Alignment	6
Drawer Alignment	7
Hinge Adjustment	8
Quiet Close Hinge Adjustment	9

Welcome to WOLF!

Have you registered your kitchen and received your WOLF Welcome Kit yet? If not, visit the website listed below and register today to receive a special thank you exclusively from WOLF:

Welcome Registration

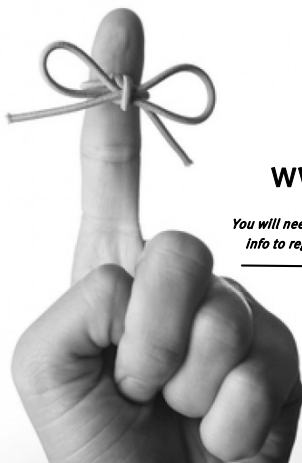

You will need this
info to register:

Now that your project is complete,
remember to register your project to
receive your 2014 WOLF Welcome Kit!

www.wolfdesignercabinets.com/register

Dealer Name: _____

Stain / Paint Color: _____

or the WOLF Order #: _____

Kit includes: Care & maintenance guide, warranty information, touch-up kit, microfiber cleaning cloth and more!
Valid on full cabinet purchases from 1/20/14 - 12/31/14. One Welcome Kit per project / address. Not valid on previous
purchases or warranty orders. NOTE: Touch up kit not available for custom paints.

WOLF
DESIGNER CABINETS
Real performance. Real value.

STAIN CHARACTERISTICS & VARIATIONS

We are confident that you will be pleased with your purchase of WOLF Designer Cabinets. As an educated consumer, you need to know the characteristics of the wood used in the finished cabinets you have purchased.

SPECIES AND FINISH

Cherry is a rich and multi-colored hardwood distinguished by its flowing grain pattern. Color varies from light to deep reddish brown and will darken or mellow with age. This will be more noticeable with natural or light stain finishes. This dramatic color change will occur with exposure to light and usually takes place within the first six months. Mineral streaks, pitch pockets, pin knots and sapwood all occur naturally in cherry and are acceptable characteristics and not considered warranty defects.

Hickory is known for its strength, open grain and distinctive color variation within each piece of wood. Ranging from light to deep brown, Hickory's unpredictable color spread is especially noticeable in a natural or light finish, with darker stains mellowing the variation. The color variation, small pin holes and knots are naturally occurring and Rustic Hickory incorporates larger sporadic knots and pin holes. These characteristics are acceptable and not considered warranty defects.

Maple offers a smooth, closed grain pattern, generally off-white in color with varying tones of light pink and yellow-brown. Maple contains a natural resin that causes the wood to turn amber as it ages. This will be more noticeable with light stain finishes and is accelerated by exposure to natural light. Other natural occurring characteristics include small, light tan or dark mineral streaks (up to 1/4" x 2 acceptable) that form when trees absorb minerals from the soil.

Oak (Red) is characterized by its wide open grain patterns and extreme durability. Variations in grain pattern and color, small knots and pin holes are attributes of nature, giving oak its distinctive beauty. Naturally occurring color variation includes light tan and pink to medium dark red and brown with occasional green, yellow and black mineral streaks. These characteristics are more prominent in natural and lighter stain finishes.

Rustic Alder has a fine, straight-grain pattern and even texture. The color is a light brown with a reddish tinge that stains evenly. Rustic Alder includes character spots, knots, burls and blemishes which do not affect the product durability. As one of the softest hardwoods, alder can be easily dented or scratched. These characteristics are not considered warranty defects.

Thermofoil doors and drawer fronts are constructed from a single piece Medium Density Fiberboard (MDF) and covered with a durable thermofoil laminate. The wood face frame is painted with a furniture quality finish to closely match the laminate. You may notice some small seams in the paint at the joints of the cabinetry face frame due to expansion and contraction of the wood. This will not affect the integrity of the cabinet or the finish. Thermofoil cabinets should not be placed adjacent to a high heat appliance; we suggest using a filler next to the heat source.

GLAZING PROCESS

The glazing process adds an additional contrasting color to the product to give an aged, worn and antique appearance. Glazing will range from an even appearance to varied coverage due to the hand application and variation in how the glaze color hangs up in the profiles of the product. The final appearance of each glaze piece will depend upon: door design, edge profile, wood characteristics and base stain color.

Glazing over Stain

The contrasting glaze will also darken the shade of the underlying stain color. Doors, drawer fronts and large mouldings are hand glazed:

- This hand applications allows for an "artisan" finish meaning no two doors or drawers will look exactly the same. The amount of hang up will vary on each door.
- In areas with deep edges, corners or unique wood characteristics, a heavier amount of glaze may collect and remain as removal will be more difficult.
- Flat and smooth areas are easier to wipe resulting in less hang up on the surface

Face frames, veneer end and back panels and small mouldings get an applied glaze so that these parts match the doors and drawer fronts.

PAINT CHARACTERISTICS & VARIATIONS

PAINT FINISH

A painted finish or painted finish with glaze product is a classic look for cabinetry. This finish is applied in the same manner and with the same quality standards that all of our other finishes are applied. It is important for you to understand that the product you have received has unique characteristics that differ from other finishes, but these are not considered quality defects.

There are three general characteristics of painted finishes that differ from other finishes:

1. The cabinetry you have selected is made from high quality hardwoods and hardwood veneers. These hardwoods, as natural products, have some seasonal movement created by changes in climatic conditions. This is normal in quality wood products. This movement can cause small, hairline cracks. These hairline cracks are normal and are not considered quality defects.
2. With use of the select hardwoods and veneers, some of the grain pattern and wood characteristics (mineral streaks, pitch pockets, checks and pin knots) as well as seams and joints will remain visible through the painted finish. These are normal and are not considered quality defects.
3. As the cabinets age there may be a slight mellowing of the color. This is affected by exposure to natural and artificial light. This is a characteristic of painted furniture and cabinetry. This mellowing of the color is normal and not considered a quality defect.

As a natural element, wood is in a constant state of expansion and contraction. This movement can cause small, hairline cracks in the wood joints of face frames and door/drawer fronts. These are normal and will not affect the integrity of the cabinet or finish. Some of the wood grain pattern and wood characteristics (mineral streaks, pitch pockets, checks and pin knots) as well as seams and joints will remain visible through the painted finish. The color mellows slightly with age; this is affected by exposure to natural and artificial light. These characteristics are normal and not considered warranty defects. Our painted Adams, Parker, Concord, Copenhagen, Pacifica, Towne and Mission painted door styles will receive a High Density MDF Center Panel. This quality panel will produce a consistent, smooth and beautiful painted finish.

Glazing over Paint

The profiles of doors, drawer fronts and large mouldings are highlighted by hand for an “artisan” finish meaning no two doors or drawers will look exactly identical. The highlight glazing affects only the areas where the glaze is applied. The rest of the product, frames, end panels and the center panels of doors do not change color.

Understanding the differences in painted finishes is important. Cracks, visible wood grain, wood characteristics and color changes are normal and not considered warranty defects or basis for replacement or credit. Neither we, the manufacturer, nor the dealer will replace product for these reasons.

Please note:	Finish Color	Standard Interior Color	Standard End Panel
Standard interior colors for your above selection	White	White	White
	Antique White	White	Antique White
	Designer Finish	Natural Maple	Natural Maple
	Custom Paint	Natural Maple	Natural Maple

NOTICE

Options to upgrade to color matching melamine or veneered plywood are available. If you are unsure of what color or material the inside of your cabinet is please consult your kitchen designer. It is common to mix different finish colors and materials to the interior of cabinets throughout a single kitchen.

CABINET CARE & MAINTENANCE

Like all investments in your home, your cabinetry will age and begin to look worn if not properly maintained. Please be sure to regularly clean and care for your cabinetry using the guidelines below.

CABINET SURFACES

Doors face frames and any stained or painted portions of your cabinetry are manufactured with a quality finish meant to protect and maintain the beauty of the wood. Interiors of your cabinets and exposed ends of standard construction are a proper laminate material meant to help resist rub marks and contain minor spills. (Construction may vary dependent on the options and features selected. See your WOLF Designer Cabinet designer for questions on the specific construction of each individual piece of your kitchen) To keep your cabinets looking their best, we encourage you to clean them monthly at a minimum.

CABINET CARE

- Avoid using a dishcloth or sponge which may have remnants of detergents and grease.
- Never use scouring pads, steel wool or powdered cleaners.
- Dry wet surfaces immediately with a soft cloth.
- Wipe up spills, splatters and water spots as they occur - keep the cabinets dry.
- Use a clean, soft, cotton cloth when wiping down cabinets. Even when thoroughly rinsed, cleaning cloths may still have remnants of bleach, detergents, grease, and other materials which can be harmful to the finish of your cabinetry.
- Use warm water. If you find that water is not strong enough, add a small amount of soap to the warm water. Never use bleach, ammonia or any cleaning agents that contain abrasives.
- Avoid draping damp clothes or dishtowels over cabinet doors. Excessive moisture can cause permanent damage.
- Do not allow oven cleaners to come in contact with wood finishes.
- Avoid placing small kitchen appliances where heat is directed onto cabinet surfaces.

EXTERIOR FINISH

- The finish on your cabinetry does not require waxing or the application of "wood oils" to maintain the wood. However if you desire a glossy or shiny appearance, you may apply furniture polish or lemon oil that is recommended for furniture use.
- Before applying polish to your cabinets, be sure they are thoroughly cleaned and dry.
- Be sure not to use any cleaning compounds that may contain alkaline agents, which can negatively impact furniture surfaces
- If not thoroughly wiped clean, polishes and oils can create either a hazy look or act as attractant to dust and dirt.
- Painting in the same room as your cabinetry? We recommend Scotch Painters Tape style 600 or 610 when preparing to paint around your WOLF Designer Cabinets.

REPAIRING SCRATCHES

WOLF provides cabinet touch-up kits that include a touch-up marker, filler pencil and fast-dry touch-up. It is important to follow the instructions included with the kit. Never use sandpaper or any other type of abrasive paper or material on a scratch. This will damage the cabinet finish.

COMMON ADJUSTMENTS

Your cabinet installer will make the necessary adjustments when completing your project. However, like most elements of your home, your cabinetry will require some minor adjustments to maintain optimal performance. Door and drawer adjustments are common — and simple — for any homeowner to perform. **NOTE: Always use a Phillips headscrew driver for adjustments. Using an electric screw gun may cause serious damage to your cabinetry.**

PROBLEM

Doors do not line up vertically



Loosen the hinge screws attaching the hinge to the door frame. Slide the door up or down until aligned, then tighten screws.

SOLUTION

Adjust hinges on door frame



PROBLEM

Too much space between doors

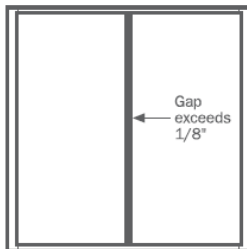

Loosen the hinge screws on the arm of the hinges and slide the door toward the middle of the cabinet. Make sure the teeth on the hinge match up, then tighten the screws.

SOLUTION

Adjust hinges on doors

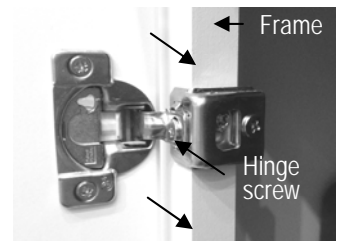

PROBLEM

Drawer does not close evenly

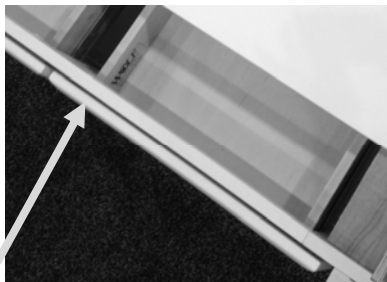

To correct drawer alignment, adjust the drawer guide member, attached from the front edge of the cabinet to the back, by manually realigning the member in the back socket (member moves to the right and to the left approximately 1/2"). Once realigned, be sure to check that the drawer guide operates smoothly.

SOLUTION

Manually adjust drawer guide member

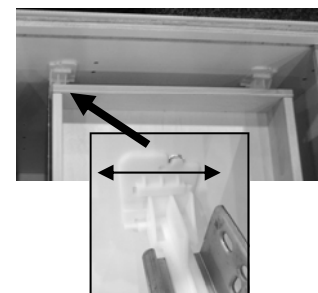

DRAWER ALIGNMENT

Disengaging the drawer

Pull the drawer out, squeeze the locking device levers and lift the drawer from the side.

Front locking device

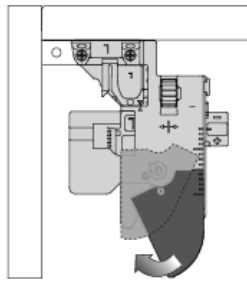

Narrow and Eco front locking device

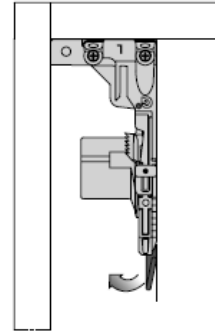

Adjusting the drawer height (max. +3.5 mm)

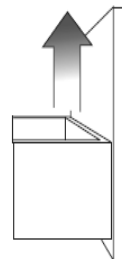

Front locking device

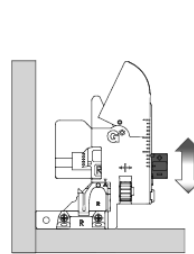

Narrow front locking device

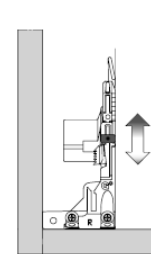

Eco front locking device

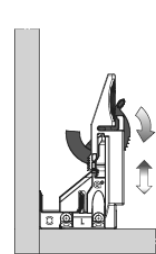

Adjusting the drawer side (max. +1.5 mm)

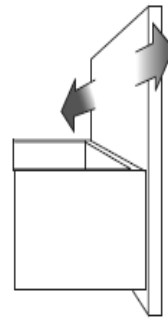

- 1 Adjust both wheels in the same direction
For 3-D application only:
- 2 Disengage drawer
- 3 Re-attach drawer

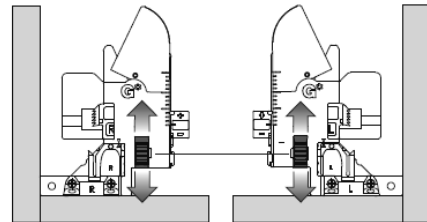

Adjusting the drawer tilt (max. +4.0 mm)

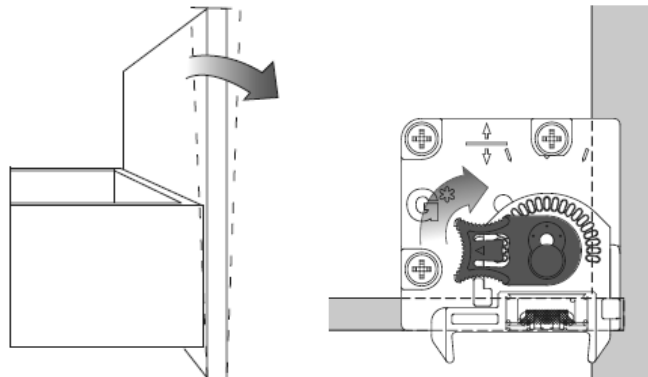

STANDARD HINGE ADJUSTMENT

The six-way adjustable hinges used on our cabinetry are durable and meant to last for years. However, periodic adjustments may be needed to tighten screws and adjust doors for level.

Adjustment

- 1 Side Adjustment +/-1.5mm [$\frac{1}{16}$ "]
Rotate cam adjustment screw.
- 2 Height Adjustment..... +/-2mm [$\frac{3}{16}$ "]
Loosen screw, align door, tighten screw.

Mounting Screws

Hinge cup to door, No. 6 x $\frac{5}{16}$ " Flat head screw
Base plate to face frame, No. 6 x $\frac{5}{16}$ " Flat head screw

Door Overlay = 37 [$1\frac{7}{16}$ "] when base plate is flush with inside edge of face frame.

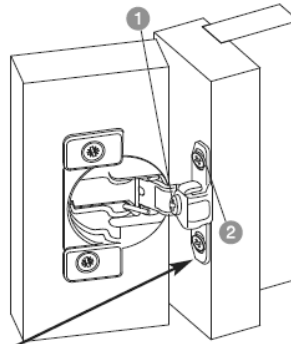

Dimensions

Overall Dimensions

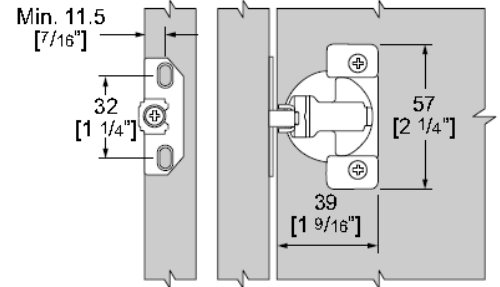

QUIET CLOSE HINGE ADJUSTMENT*

SOFT-CLOSE HINGES *

The soft-close hinges are more convenient than ever. Each hinge is adjustable to fit any door, and close to any pressure.

- 1 Side Adjustment: Rotate cam adjustment screw
- 2 Height Adjustment: Loosen screw, align door, tighten screw
- 3 Depth Adjustment: Loosen screw, align door, tighten screw
- 4 Soft-close Tension: Light, medium and strong settings

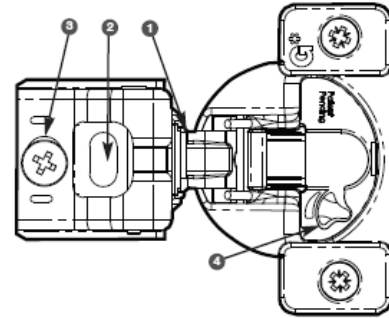

LIGHT

- 1 This is the "Light" setting for the Soft-closing mechanism. Set here for light or small doors with very little closing pressure.

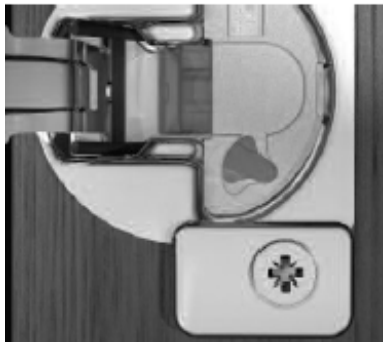

MEDIUM

- 2 This is the "Medium" setting for the Soft-closing mechanism. Set here for average size doors with normal closing pressure.



STRONG

- 3 This is the "Strong" setting for the Soft-closing mechanism. Set here for larger or heavier doors with a strong closing pressure. (Factory Setting)

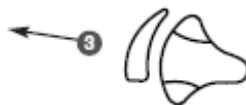

Note: To reset the Soft-close damper, move the adjustment switch to "Strong", then to the desired position. Close the door and the Soft-close will be reset.

* Quiet close hinges are an optional feature on WOLF Designer Cabinets selected at the time of purchase. Most doors include one quiet close hinge and remaining hinges are standard six-way adjustable hinges.

LIMITED LIFETIME WARRANTY

WOLF Designer Cabinets are manufactured for WOLF and this warranty is issued by Norcraft Companies, referred to below as "the Manufacturer."

The Manufacturer warrants its products by providing a limited lifetime warranty to the original consumer purchaser during the period in which they own their home. Should any of our products fail due to defects in material or workmanship under normal use within this period, the Manufacturer will, at its own discretion, repair or replace the defective part. This warranty is not transferable.

This warranty does not cover products which are misused, abused, mishandled, improperly installed, improperly stored, changed, modified, or are subjected to extreme temperatures or extreme moisture levels. This warranty is not valid for products used for any purpose other than the purpose for which they were originally intended.

This warranty does not cover the cost of installation, removal, subsequent damage, or transportation of the defective product, regardless of whether work was performed by a contractor, Service Company or yourself.

Variations in color and grain pattern are a natural characteristic of wood. Color changes may occur as a result of aging, exposure to light, heat and other natural and chemical elements. Color variations and changes are not covered by this warranty.

In addition, all hinges and drawer slides used in the manufacture of the products are warranted by the Manufacturer of the hinges and slides for the lifetime of the product. This warranty is passed to the original consumer purchased by the Manufacturer from the slide and hinge Manufacturer and is subject to the conditions outlined in paragraph two and three above.

The repair(s) or replacement(s) of our products are contingent on availability of the items. If a warranty claim is filed after the product has been discontinued or modified, the Manufacturer reserves the right to honor the warranty in the following fashions.

1. To repair or replace the affected component with a new component of the same style.
2. To repair or replace the affected component with similar and comparable product to achieve a similar appearance to the original product purchased.

If components are replaced, the Manufacturer cannot guarantee the exact finish match to the existing product. This is due to color calibration adjustments and the natural aging process of wood.

This warranty is the exclusive warranty of the Manufacturer and is in lieu of all other warranties, express or implied. In no event shall the Manufacturer be liable for the consequential, indirect or incidental damages resulting from the installation, use, or failure of its product.

Some states do not allow the exclusion or limitation of incidental or consequential damages, so the above limitations or exclusions may not apply to you. This limited warranty gives you specific legal rights. You may also have other rights that vary from state-to-state.

To submit a claim under this warranty, contact the nearest WOLF Designer Cabinet dealer, or send a letter explaining the defect, with dated sales receipts as proof of purchase to (do not send merchandise unless requested by the claims department):

ATTN: WOLF Designer Cabinets - Claims, Norcraft Companies, 3020 Denmark Avenue, Suite 100, Eagan, MN 55121
Phone: (651) 234-3300 ~ Fax: (651) 234-3398

